

Varenummer: 438000018

Beskrivelse: Rota-fix spændelement SD 18

## Mål

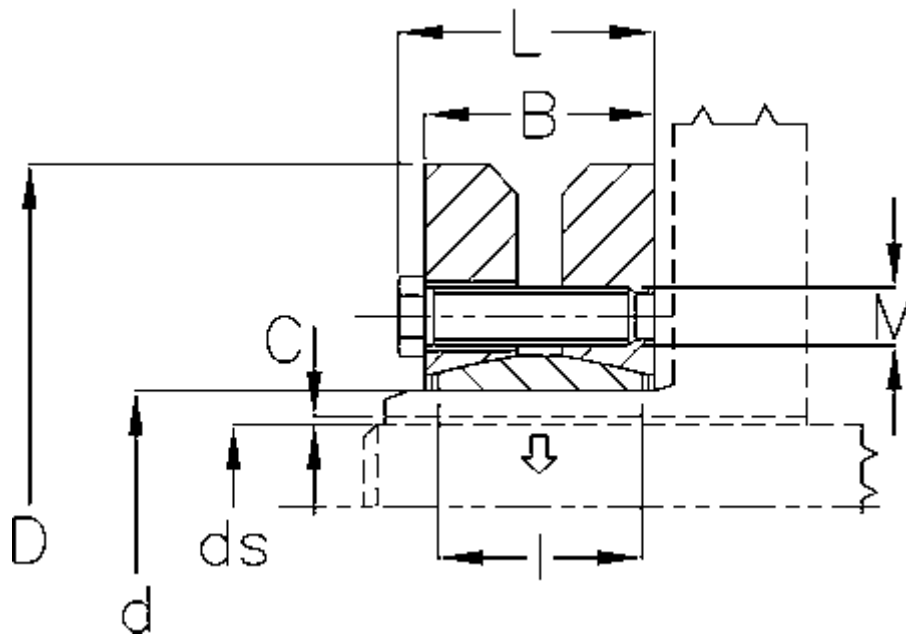

B mm	= 15
C maks.	= 0,017
d H8 mm	= 18
D mm	= 44
ds mm	= 14
F kN aksialkraft	= 16
L mm	= 19
l mm	= 12

M mm	= M5
T Nm drejningsmoment	= 85
Ts Nm boltetilspændingsmoment	= 4